

'Z Bend' Lead Subminiature SMD LED

VL K928

Description

This series of leaded SMD LED is also known as Subminiature LED. There are 'Gull Wing', 'Yoke Bend' and 'Z Bend' type of lead forming but straight lead is available as well. The dice used in this series (Red /Green / Yellow is AlGaInP rather than the conventional GaP and GaAsP/GaP. The advantages of AlGaInP are low power consumption and obtaining high luminous intensity under low current driving condition.

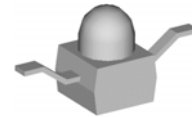

Applications

- Industrial control systems signal indicator
- Automotive features
- Front panel indicator
- Status indication



Electronic Optical Characteristics (at 20mA):

Part Number	Emitted Color	λ (nm)		Lens Color	Iv(mcd)		View Angle (2 θ 1/2)	VF(V)	
		λ d	λ p		Min.	Typ.		Typ.	Max.
VL K928	Orange 	615	621	Clear	250	510	25	2.0	2.4

Absolute Maximum Ratings (at Ta=25°C)

P _D (mW)	I _{FP} (mA)	I _F (mA)	Iron Solder (°C)	I _R (μ A)@V _R =5V	Topr(°C)	Tstg(°C)
60	100*	25	350 \pm 5 for 3 sec.	10	-40~+85	-40~+100

Note: Please take note the Absolute Maximum Rating values. Any operation beyond the specify ratings in this table will result degradation of LED life-span and may cause LED to fail.

* I_{FP}: Peak Forward Current under 1/10 duty, 1KHz condition

Package Dimension:

unit : mm

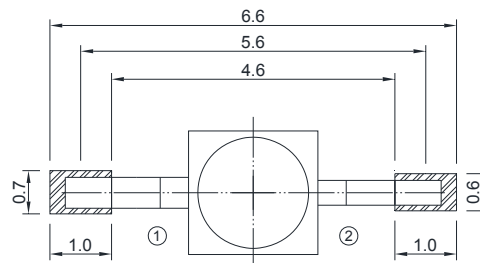
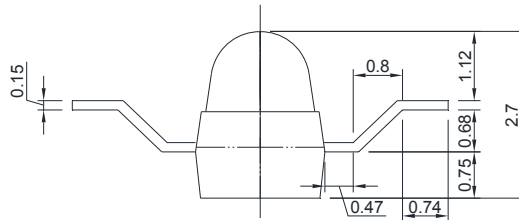
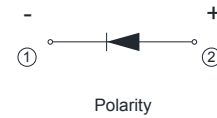
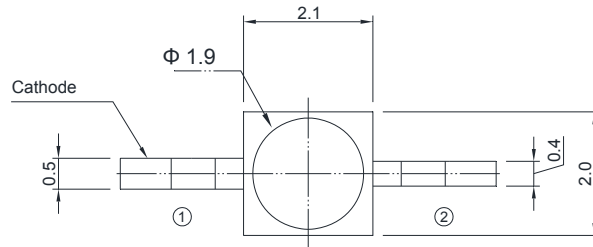

Recommend Soldering Pad

Notes:

1. All dimensions are millimeters.
2. Tolerance is $\pm 0.2\text{mm}$ unless otherwise specified.
3. Specifications are subject to change without notice.

Optical Characteristics Curves

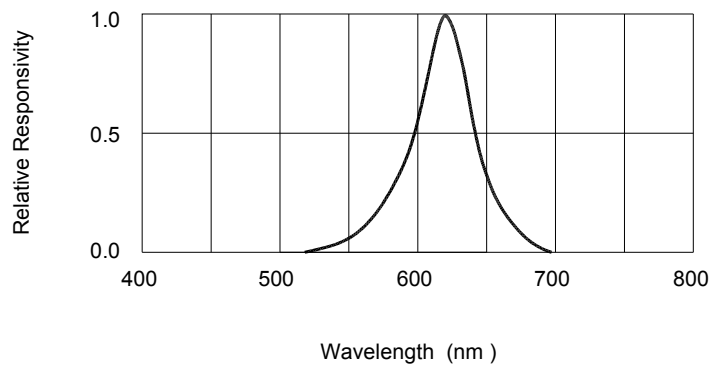
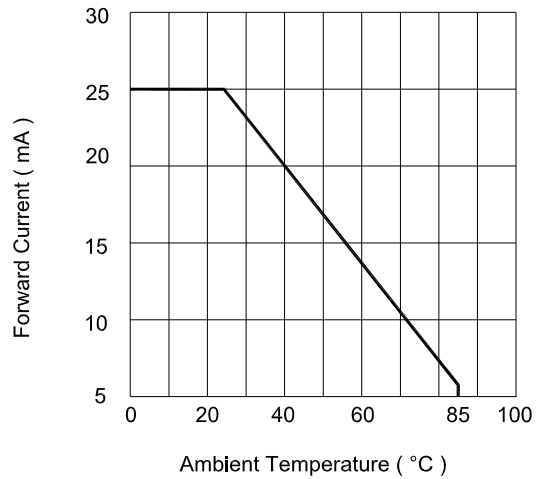
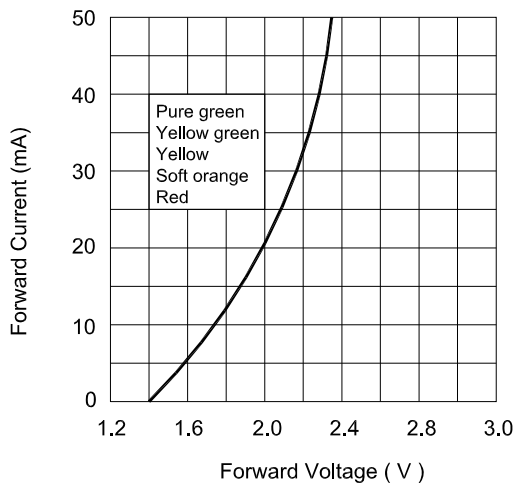
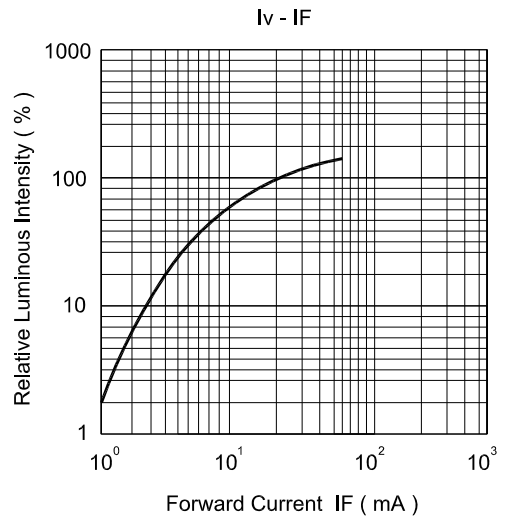
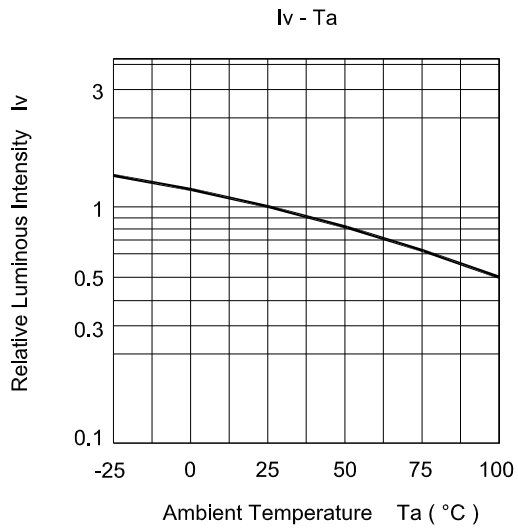

Reel Dimension:

unit : mm

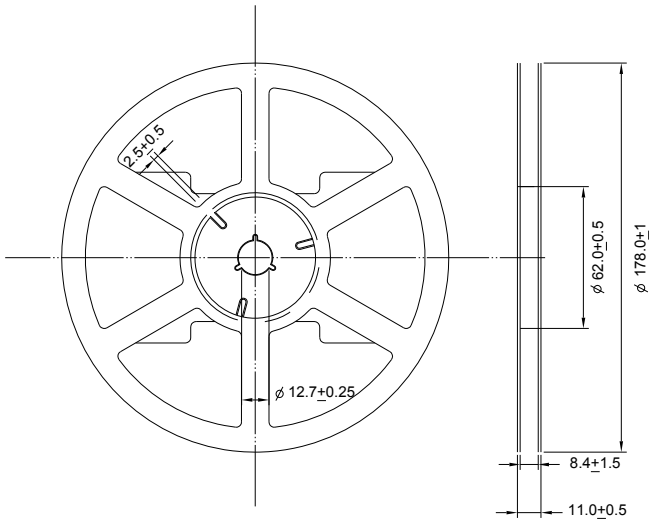

Note:

Available in 8mm carrier tape on 178mm diameter reels. (1,000 pieces)

USER FEED DIRECTION

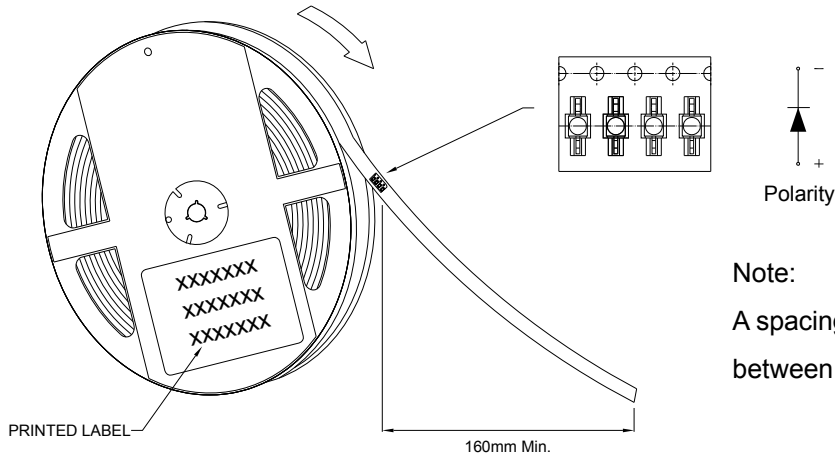

Note:

A spacing of approximately 160mm between the front edge of tape

Tape Dimension:

unit:mm

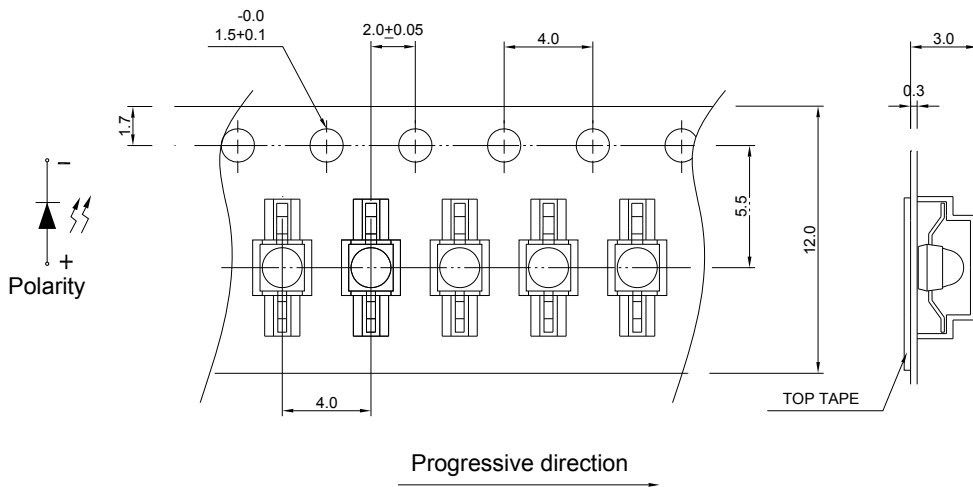

Recommended Pb-free re-flow soldering profile:

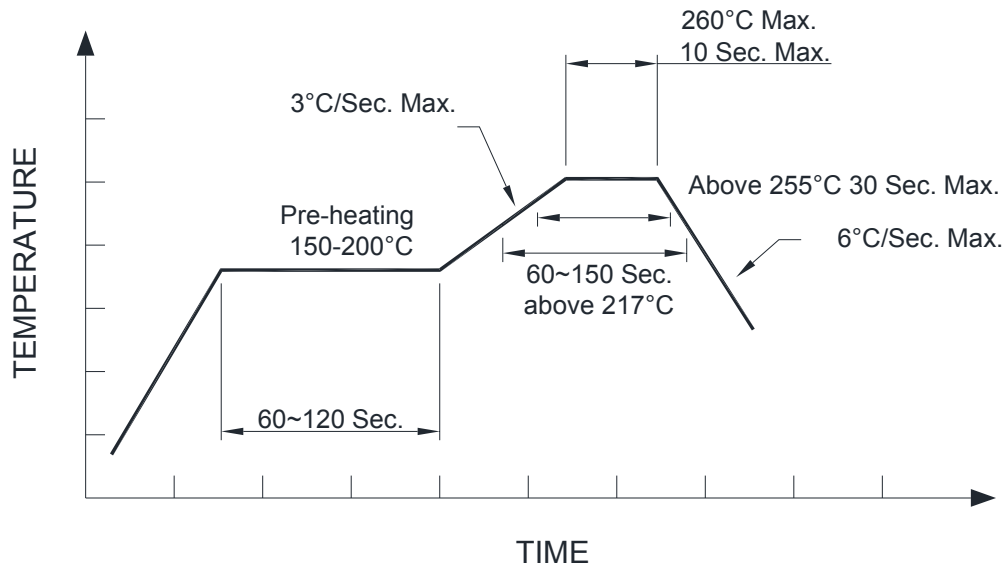

Note:

All the specifications listed in this data sheet are suitable for general electronic equipment, office equipment and communication devices. Kindly consult Sales Representatives for specific reliabilities request, Forward Voltage, Luminous Intensity, Wavelength, Radiant Power or Viewing Angle.